

# 600 Watt Industrial



## Features

- 5 x 8.5 x 1.61 inches
- Universal input
- Current Sharing Option
- Peak Power Capability
- 5 Vdc Stand by
- 12 V fan output
- Power Good / Power Fail Signal
- Suitable in POE applications
- Lesser than 1U high
- Having high voltage output range up to 58VDC
- N+1 redundant power supply
- Single wire current sharing
- Built in OR-ing diode / FET (- R suffix)

## Electrical Specifications

Input Voltage	85–264 VAC/120–390 VDC, Universal	
Input Frequency	47–63 Hz	
Input Current	120 VAC: 6.5 A max.	240 VAC: 3.2 A max.
Input Protection	F16A/250V in Live & Neutral both	
No Load Power	Typ 3W over entire input range with main output kept off using Remote ON/OFF	
Leakage Current	400 $\mu$ A @ 240 VAC / 50 Hz	Touch Current : < 100 $\mu$ A
Inrush Current	240 VAC: 25 A max.	
Efficiency	120 VAC: 88% Typical 240 VAC: 93%	
Hold-up Time	120 VAC: 8 ms	240 VAC: 8 ms
Power Factor	120 VAC: 0.98 240 VAC: 0.95	
Output Power	600W Convection (U-Channel),420 W(Slotted Cover),360 W (Plain Cover), Peak 720W for 1ms.	
Line Regulation	+/-0.5%	
Load Regulation	+/-1%	
Transient Response	< 10%, 50% to 100% load change, 50 Hz, 50% duty cycle, 0.1 A/ $\mu$ s, recovery time < 5 ms	
Rise Time	<100 ms	
Set Point Tolerance	+/-1%	
Output Adjustability	+/-3%	
Over Current Protection	110% Typ, Hiccup Type, Autorecovery	
Over Voltage Protection	114%, Latch Type ,AC Power to be recycled for recovery	
Short Circuit Protection	Latch Type ,AC Power to be recycled for recovery	
Over Temperature Protection	130-140°C primary heat sink, autorecovery	
Current Share	Upto 3 supplies can be connected in parallel (optional)	
Switching Frequency	PFC converter:Variable, 85 kHz typical Resonant converter:Variable, 100 kHz typical	
Operating Temperature	-40 to +70°C, refer derating curve	
Storage Temperature	-40 to +85°C	
Relative Humidity	95% Rh, noncondensing	
Altitude	Operating: 16,000 ft.; Nonoperating: 40,000 ft.	
MTBF	3.37m Hours, Telcordia -SR332-issue 3	
Isolation Voltage	4000 VDC between input to output, 2500 VDC input to Earth	
Cooling	Convection: 600 W (U-Channel),420 W(Slotted Cover),360 W (Plain Cover)	

Model Number	Type	Voltage	Max. Load (Convection)	Min. Load	Ripple <sup>1</sup>
VPS600-1012	U-Channel	12 V	25 A	0.0 A	2%
VPS600-1015	U-Channel	15 V	25 A	0.0 A	2%
VPS600-1024	U-Channel	24 V	25 A	0.0 A	2%
VPS600-1030	U-Channel	30 V	20 A	0.0 A	2%
VPS600-1048	U-Channel	48 V	12.5 A	0.0 A	2%
VPS600-1058	U-Channel	58 V	10.34 A	0.0 A	2%
VPS600-1S12	U-Channel + Slotted	12 V	17.5 A	0.0 A	2%
VPS600-1S15	U-Channel + Slotted	15 V	17.5 A	0.0 A	2%
VPS600-1S24	U-Channel + Slotted	24 V	17.5 A	0.0 A	2%
VPS600-1S30	U-Channel + Slotted	30 V	14 A	0.0 A	2%
VPS600-1S48	U-Channel + Slotted	48 V	8.75 A	0.0 A	2%
VPS600-1S58	U-Channel + Slotted	58 V	7.25 A	0.0 A	2%
VPS600-1T12	U-Channel + Cover	12 V	15 A	0.0 A	2%
VPS600-1T15	U-Channel + Cover	15 V	15 A	0.0 A	2%
VPS600-1T24	U-Channel + Cover	24 V	15 A	0.0 A	2%
VPS600-1T30	U-Channel + Cover	30 V	12 A	0.0 A	2%
VPS600-1T48	U-Channel + Cover	48 V	7.5 A	0.0 A	2%
VPS600-1T58	U-Channel + Cover	58 V	6.2 A	0.0 A	2%

To order product with the redundancy diode option please add the suffix-R to your required part number. For Example - VPS600-1012-R  
Refer VPS800 Series datasheet for upgraded 800 W version

Pin Connections		
J1	1	AC LINE
	2	NEUTRAL
	3	EARTH
J2	J2-A	+VE
	J2-B	-VE
J3	Pin 1	GND
	Pin 2	5V AUX
	Pin 3	PGPF
	Pin 4	VS -
	Pin 5	VS +
	Pin 6	GND
	Pin 7	RMT
	Pin 8	CL2
	Pin 9	CL1
	Pin 10	LS
J10,J11 (FAN OUTPUT)	Pin 1	+ VE
	Pin 2	- VE



## Notes

1. For Ripple measurement minimum output power requirement is 25 W.

Ripple is peak to peak with 20 MHz bandwidth and 10  $\mu$ F (Electrolytic capacitor) in parallel with a 0.1  $\mu$ F capacitor at rated line voltage and load ranges.

2. Combined output power of main output, fan supply and standby supply shall not exceed max. power rating.

3. Standby output voltage 5 V/ 1.5A(convection) with tolerance including set point accuracy, line and load regulation is +/-10%.

Ripple and noise is less than 5%.

4. Specifications are for nominal input voltage, 25°C unless otherwise stated.

5. PSU is supplied with J3, pin-6 and pin-7 shorted to enable main output without remote on/off feature.

6. Fan supply output voltage is 12V/500mA with regulation band+/-30 % and Ripple is less than 10%. To get 12V Fan supply output voltage, minimum 10 % load on Main output voltage is required.

## Mechanical Specifications

AC Input Connector (J1)	TE Connectivity: NC6-P107-03
DC Output Connector (J2)	6-32 inches Screw Pan HD Mating: Designed to accept Ring Tongue Terminal AMP : 8-31886-1, wherein one 16 AWG(max) wire can be crimped. Note : One Ring Tongue Terminal with 16 AWG is recommended for current upto 11A only. Use multiple tongue terminals with wire for more current.
Signal Connector (J3)	Molex: 22-23-2101 Mating: 22-01-2107; Pins: 08-50-0113
J10, J11 (Fan Output)	Make : TE Connectivity AMP Connectors Description: CONN HEADER VERT 2POS 2.54MM MPN : 640456-2 Mating : 3-641535-2 / TE Connectivity AMP Connectors OR 0022013027 / MOLEX with crimping 08-50-0114 / MOLEX
Dimensions	5.0 x 8.5 x 1.61 inches (127 x 216 x 41 mm)
Weight	1.1 kg

## EMC

Parameter	Conditions/Description	Criteria
Conducted Emissions	EN55032	Class B
Radiated Emissions	EN 55032	Class A (Class B with External king core K5B RC 25x12x15-M or equivalent)
Input Current Harmonics	EN 61000-3-2	Class A
Voltage Fluctuation and Flicker	EN 61000-3-3	Complies
ESD Immunity	EN 61000-4-2	A
Radiated Field Immunity	EN 61000-4-3	A
Electrical Fast Transient Immunity	EN 61000-4-4	A
Surge Immunity	EN 61000-4-5	A
Conducted Immunity	EN 61000-4-6	A
Magnetic Field Immunity	EN 61000-4-8	A
Voltage dips, interruptions	EN 61000-4-11	A & B

## Safety

CE Mark	Complies with LVD Directive
Approval Agency	Nemko, UL, C-UL
Safety Standard(s)	IEC/EN 62368-1,ED 2 UL62368-1,CSA C22.2 No. 62368-1
Safety File Number(s)	UL Certificate No : 20190313-E150565 CB Test Certificate No : N0105325 Nemko Certificate No : P19223362



## Signal(s)

Power Good / Power Fail Signal  
The delay is 0.1 s to 0.5 s  
  
value at AC Power off

Power Good : Is a TTL signal which goes high after main output reaches 90% of its set value.  
  
Power Fail : The same signal goes low at least 1ms before main output falls to 90% of set

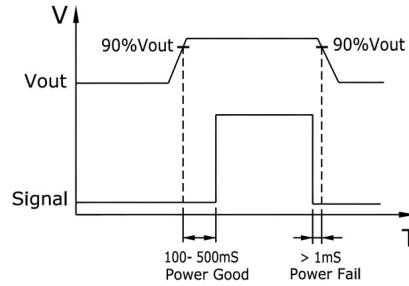

Remote Sense

Compensates for 200 mV drop

Remote on/off

Pin 6 & Pin 7 of J3 can be used for Remote on/off.

Shorting Pin 6 to Pin 7 enables main output while keeping the pins open disables main output

Note: - Provision of Inhibit Remote ON/OFF is available. +5V at Pin 7 will switch off the main output.

OCP limit set

Pin 8 & Pin 9 of J3 must be left open

## Derating Curve

Power Derating w.r.t Input

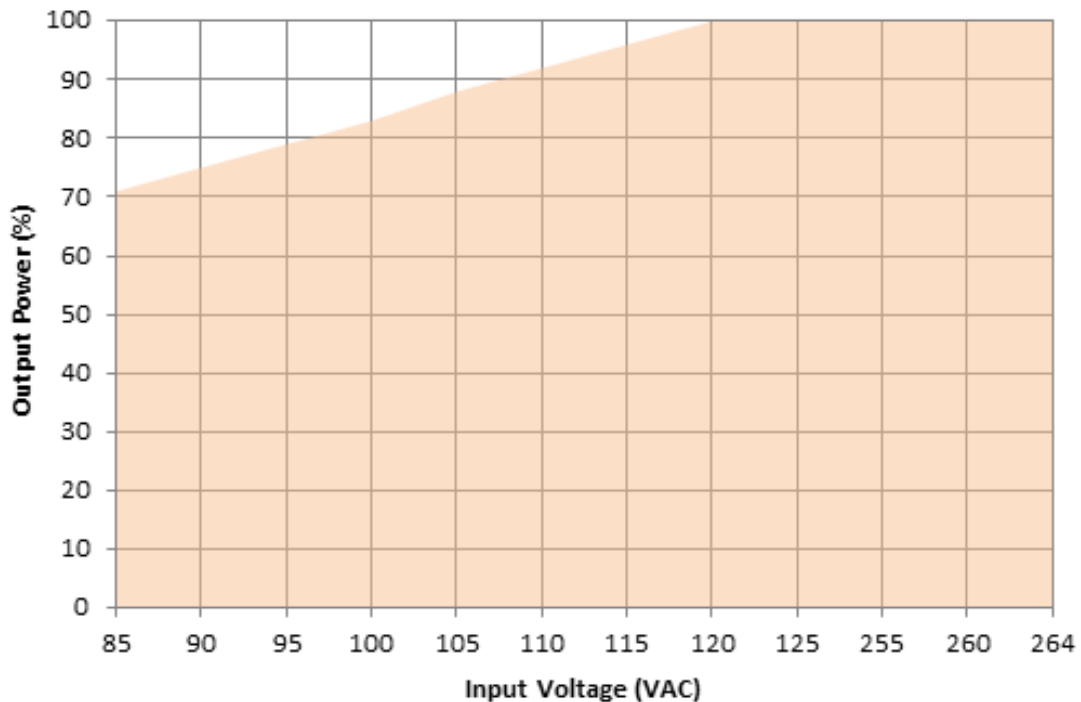

## Derating Curve

### Derating Curve 12 V

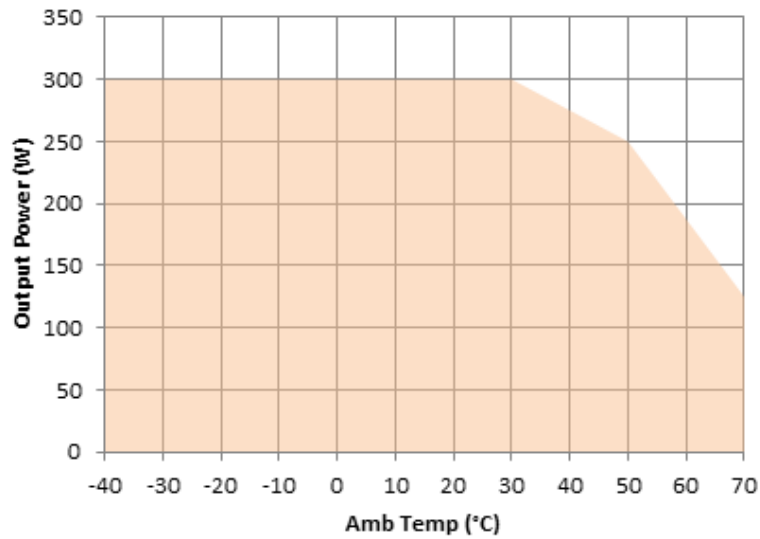

Convection load: 300W up to 30 °C  
De-rate between 30-50 °C @ 0.833% per °C  
De-rate above 50 °C @ 2.5% per °C

Convection

### Derating Curve 12 V for slotted cover

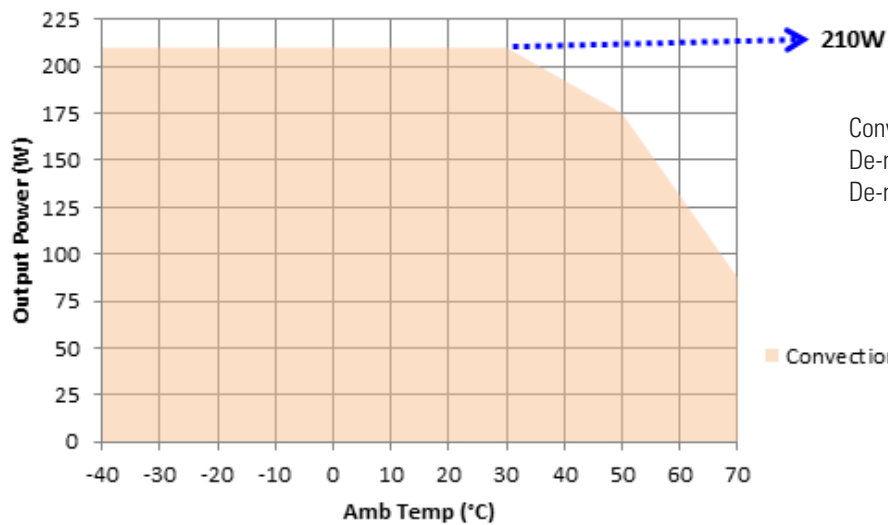

Convection load: 210W up to 30 °C  
De-rate between 30-50 °C @ 0.833% per °C  
De-rate above 50 °C @ 2.5% per °C

Convection



## Derating Curve

### Derating Curve 12 V for plain cover

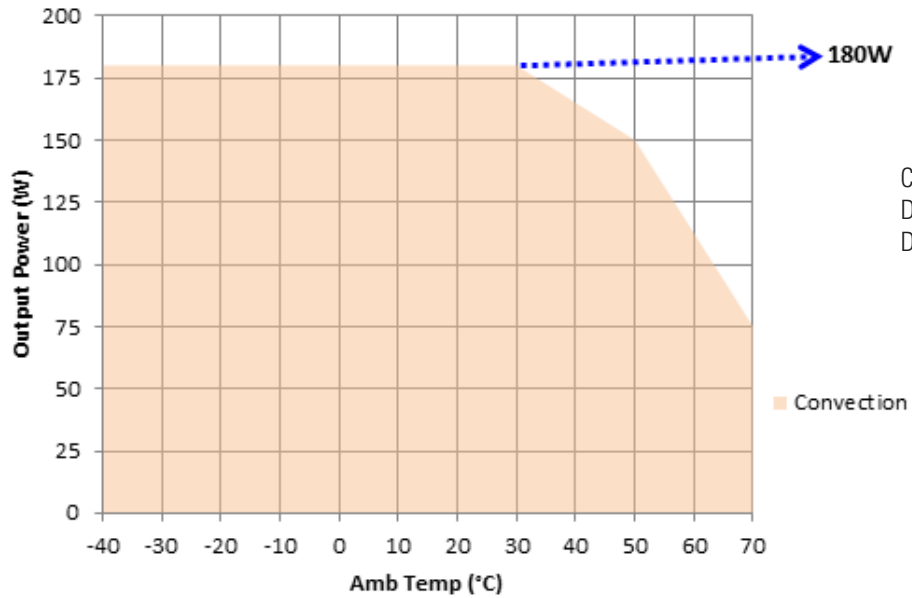

Convection load: 180W up to 30 °C  
De-rate between 30-50 °C @ 0.833% per °C  
De-rate above 50 °C @ 2.5% per °C

### Derating Curve 15 V

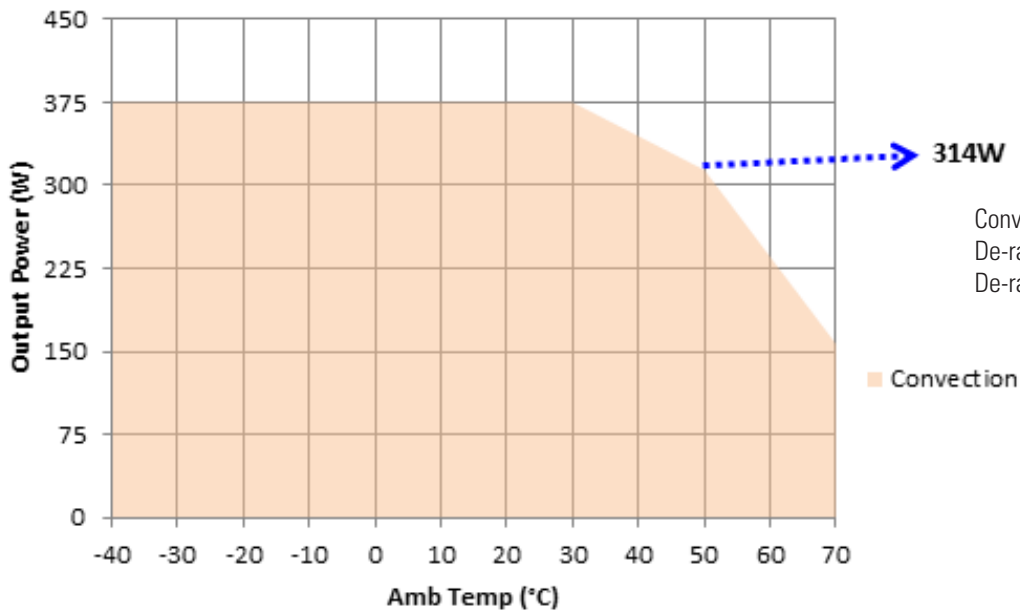

Convection load: 375W up to 30 °C  
De-rate between 30-50 °C @ 0.8133% per °C  
De-rate above 50 °C @ 2.5% per °C

## Derating Curve

### Derating Curve 15 V slotted cover

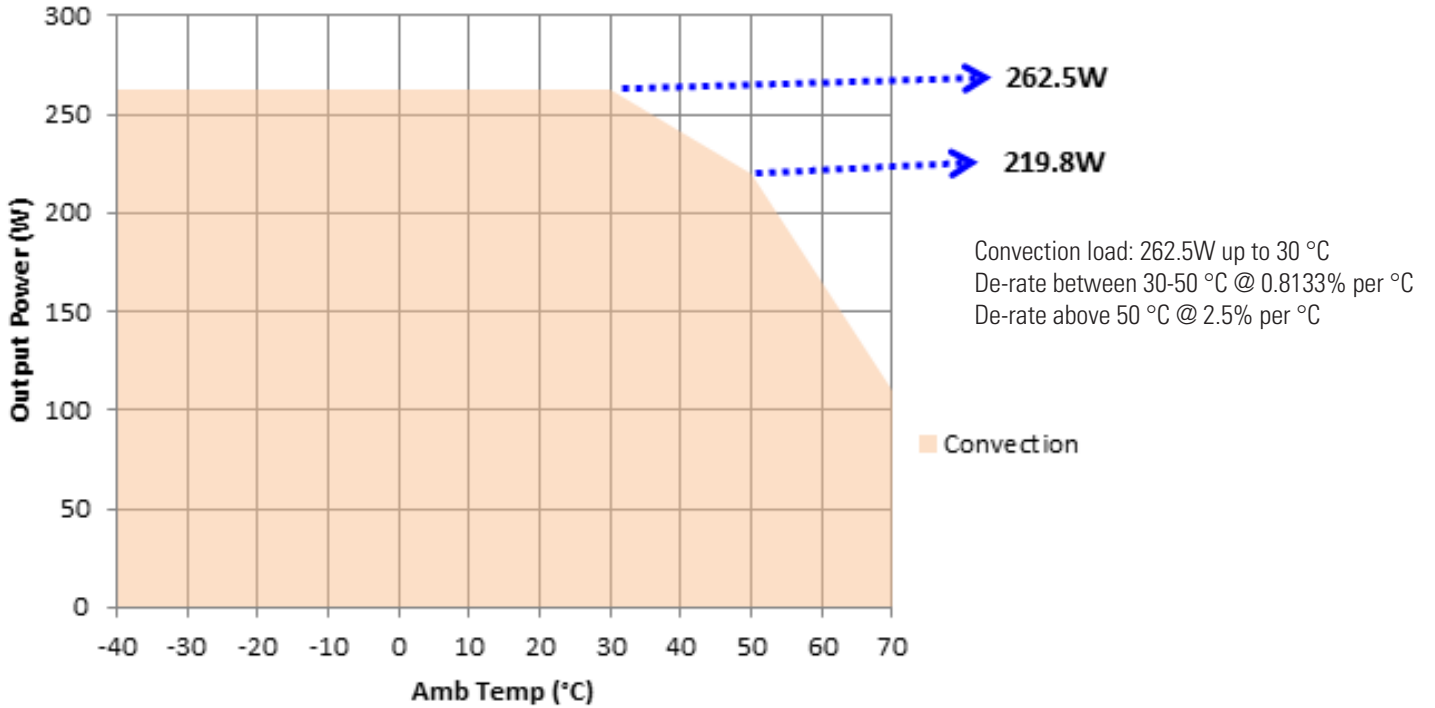

### Derating Curve 15 V plain over

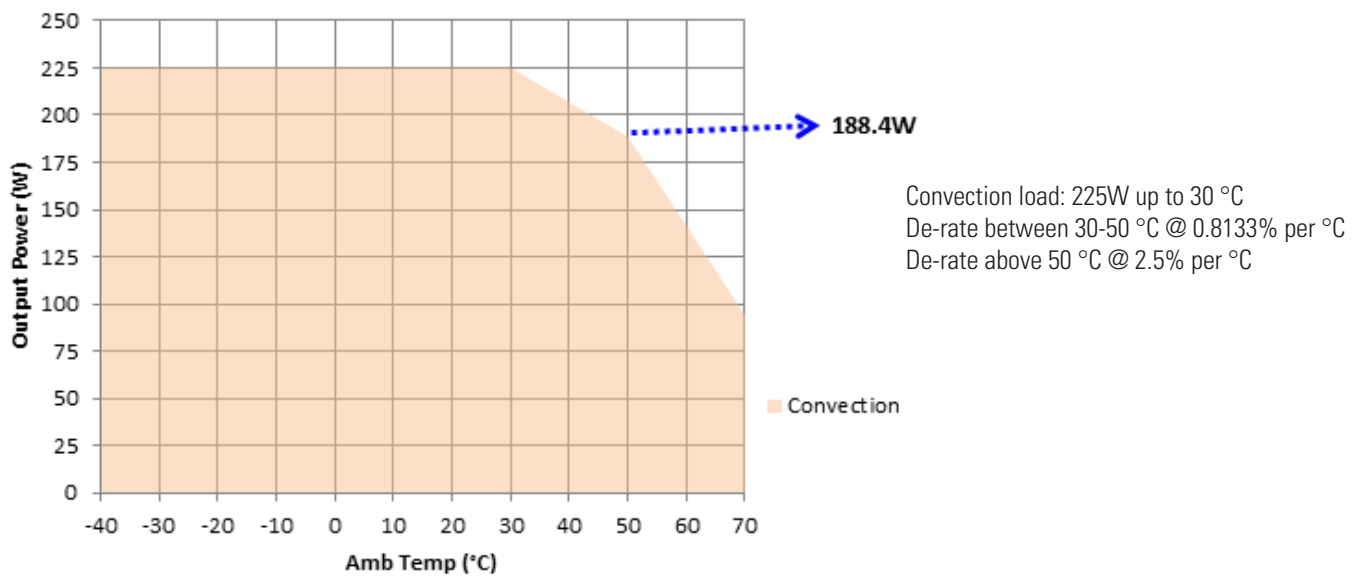



## Derating Curve

### Derating Curve 24 V & above

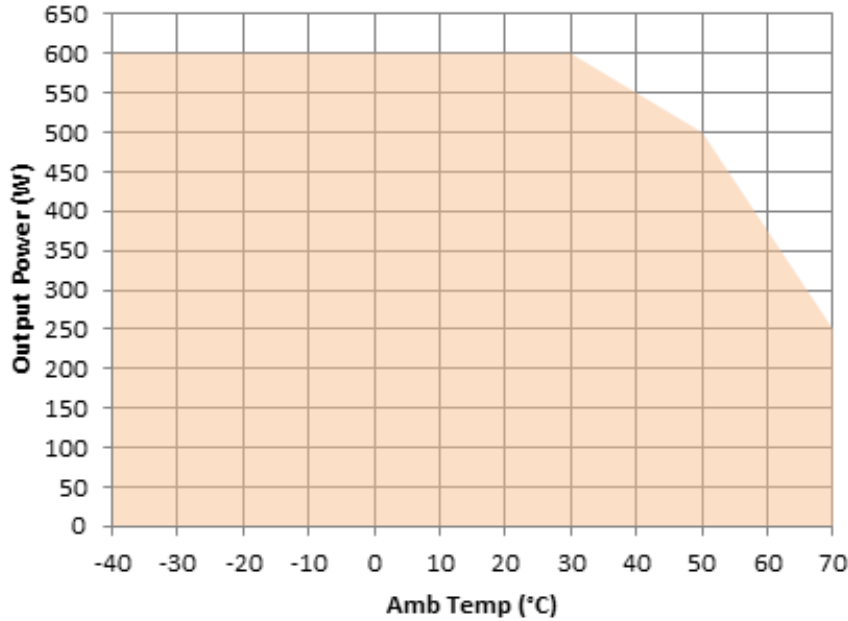

Convection load: 600W up to 30 °C  
De-rate between 30-50 °C @ 0.833% per °C  
De-rate above 50 °C @ 2.5% per °C

Convection

### Derating Curve 24 V & above for slotted cover

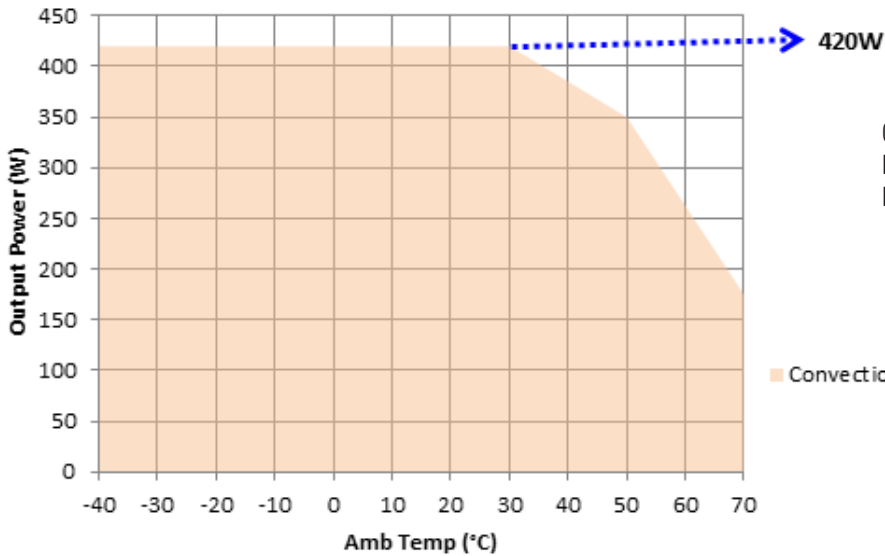

Convection load: 420W up to 30 °C  
De-rate between 30-50 °C @ 0.833% per °C  
De-rate above 50 °C @ 2.5% per °C

420W

Convection



# Derating Curve

## Derating Curve 24 V & above for plain cover

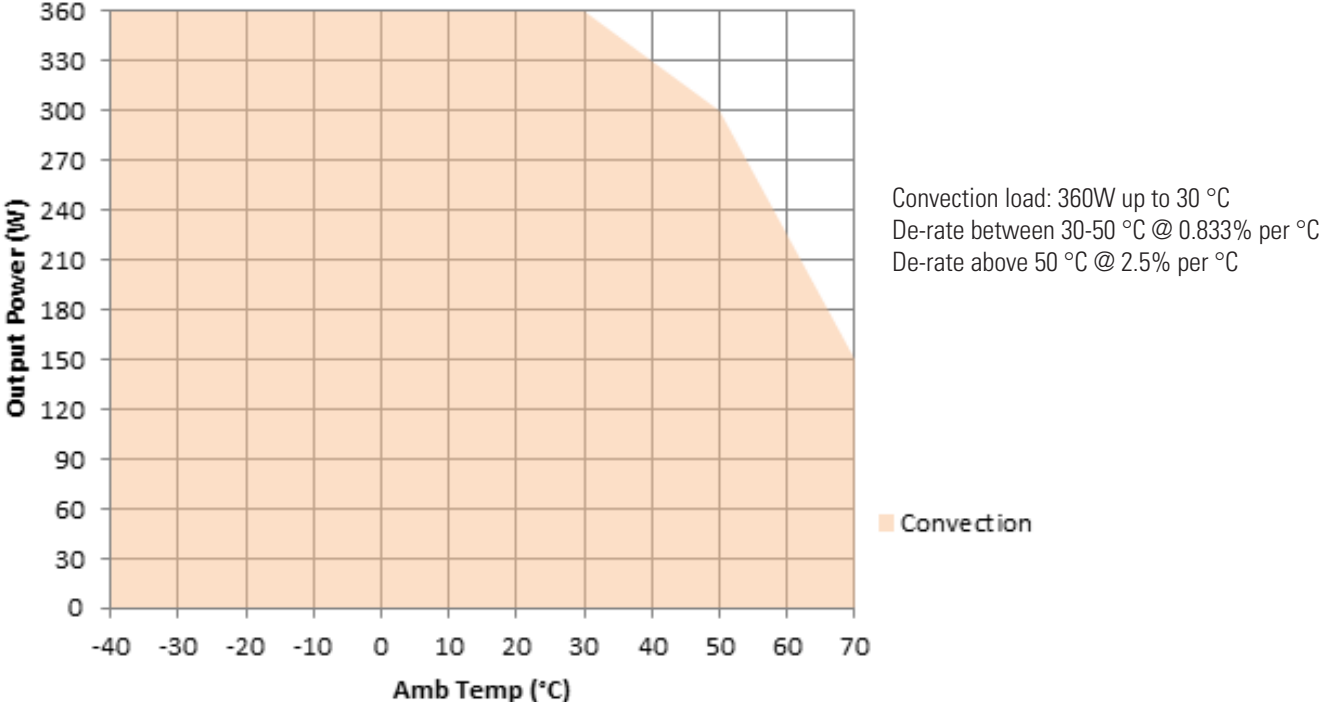

# Mechanical Drawing

## Option - 1 (U-Channel)

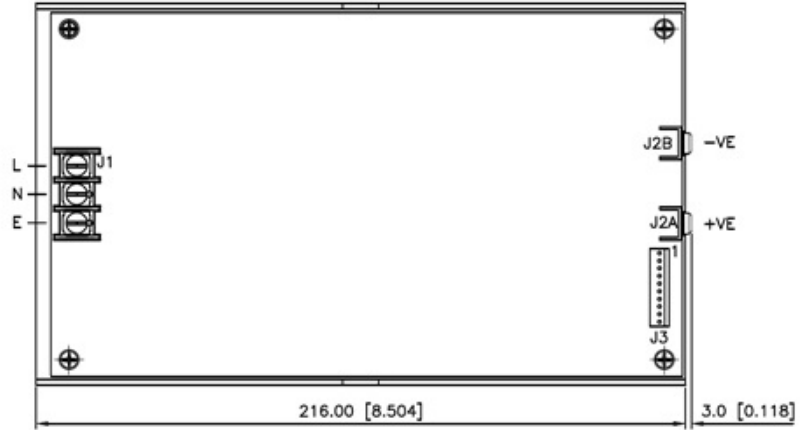
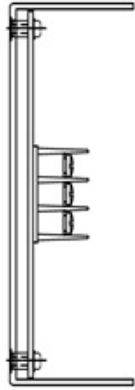

TOP VIEW

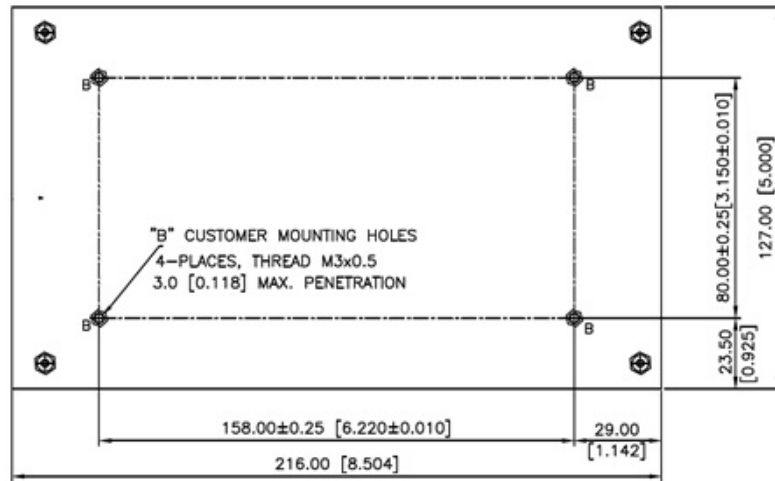

BOTTOM VIEW

MECHANICAL OUTLINE DIMENSIONS  
 ALL DIMENSIONS ARE IN MM [INCHES]  
 GEN.TOLERANCE: ±1.0 MM [±0.04"]



# Mechanical Drawing

## Option - 2 (Slotted Cover)

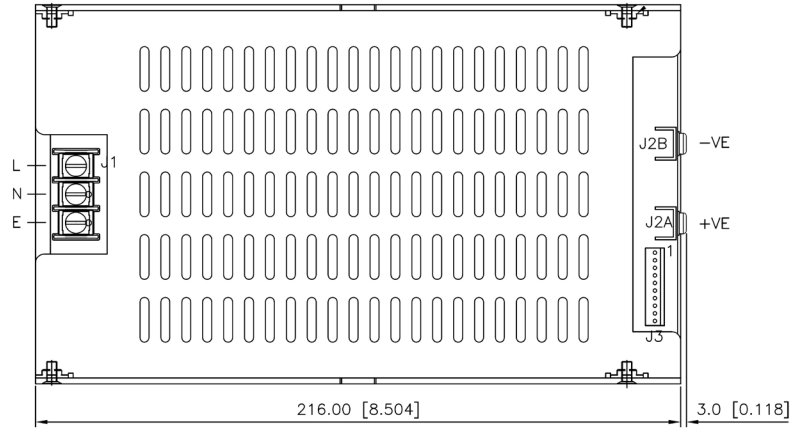
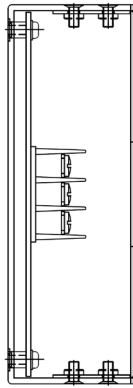

TOP VIEW

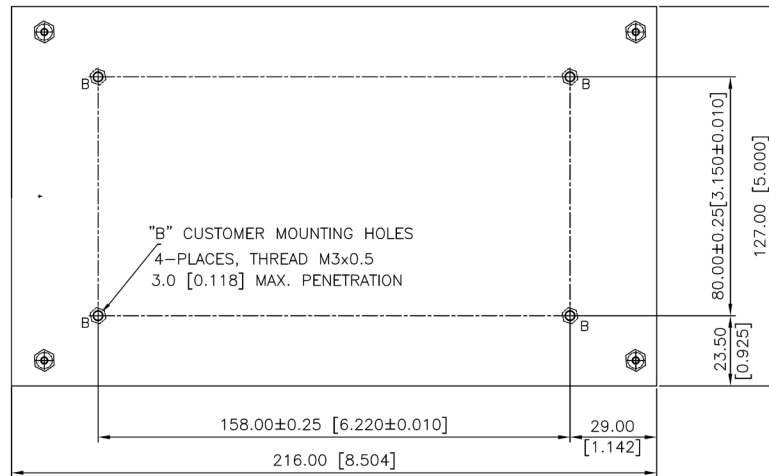

BOTTOM VIEW

MECHANICAL OUTLINE DIMENSIONS  
 ALL DIMENSIONS ARE IN MM [INCHES]  
 GEN.TOLERANCE:±1.0 MM [±0.04]

# Mechanical Drawing

## Option - 3 (Plain Cover)

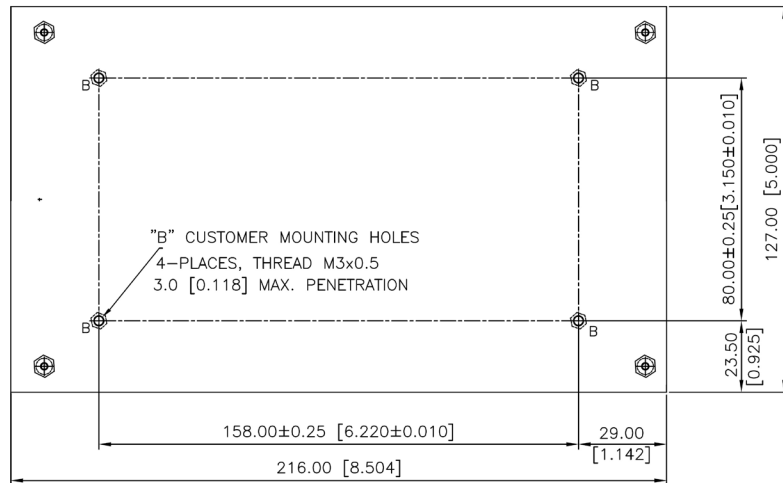
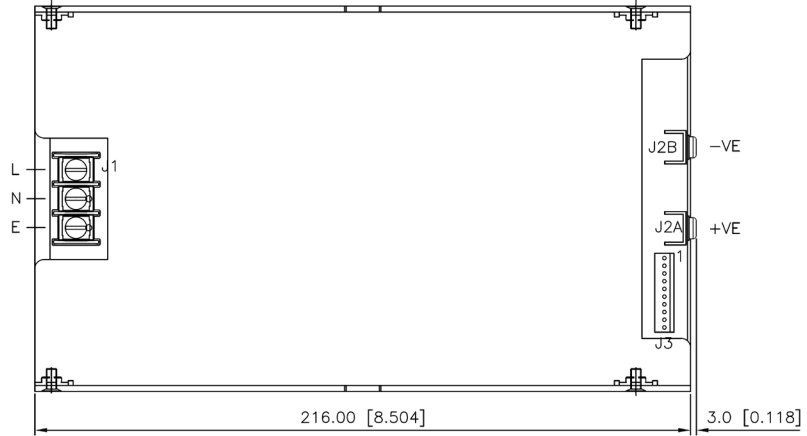
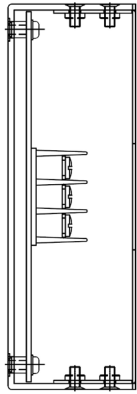

MECHANICAL OUTLINE DIMENSIONS  
 ALL DIMENSIONS ARE IN MM [INCHES]  
 GEN.TOLERANCE:±1.0 MM [±0.04]



### Installation instruction for current sharing:

During the installation and setup of parallel supplies in a system it is important that a single remote sense point be used for all the supplies. The remote sense voltage between the supplies must be adjusted to within 1% to ensure the supplies are inside the 1% capture window. If the supplies are not initially adjusted inside the capture window the supplies will not current share satisfactorily.

### Set-Up Procedures:

1. Connect load cables to the outputs of each supply.
2. Connect the remote sense lines to the load in twisted style . (A common remote sense point must be used for all the supplies in parallel).
3. Connect all the "LS" signal(Pin 10) on the J3 connector between the supplies.
4. Adjust remote sense voltage of each supply to within 1% of rated output voltage or readjust to required set point. (Adjustment to be done with all other parallel supplies off).
5. Current sharing between the supplies can be verified by monitoring the output current of each supply with a hall effect DC current probe. The supplies should share to within 10% of the total load current. The maximum recommended power output for three units in parallel would be 1620W.
6. The current share circuit has a capture window voltage of +/- 1% of the rated output voltage. If the output remote sense voltage of one of the supplies is adjusted outside the 1% window the supplies will not current share satisfactorily.

